

Article number: 2026430MCR
Description: E+G GN 264
outside diameter 30 mm, 24 mm bore

Measures

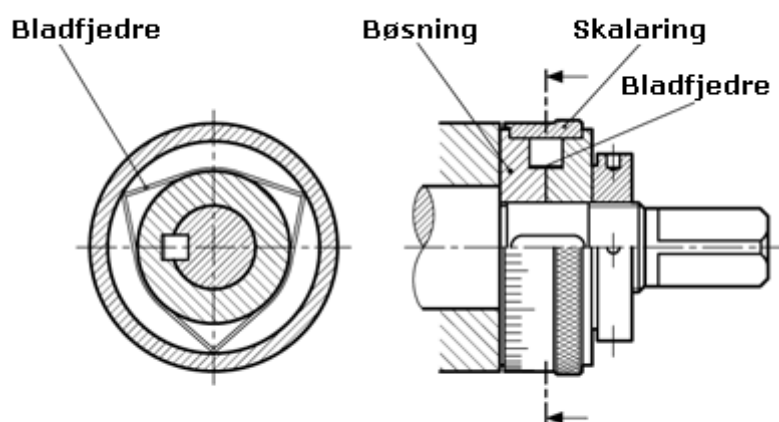

Bore	= -
External diameter	= 30
Handle diameter	= 33
Internal diameter	= 24
Item	= -
Item	= -
Item	= -
Length	= 23.7